

# K 1168

design Valli Workshop

## Materiale Ottone

Material Brass

## Finiture / Finishes

Cromo

Cromsatin

# K 1166

design Valli Workshop

## Materiale Nikrall Lega Zama UNI 3717

Material Nikrall Lega Zama UNI 3717

## Finiture / Finishes

Cromo

Cromsatin

Zirtanio Oro Lucido

Valli&Valli

ASSA ABLOY

K 1168 R8  
K 1168 R8 Y

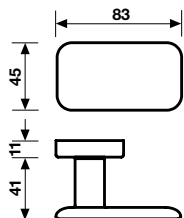

K 1166

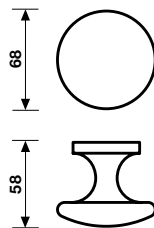

# K 1165 Serie Bess

design Yoshimi Kono

**Materiale Nikrall Lega Zama UNI 3717**

*Material Nikrall Lega Zama UNI 3717*

**Finiture / Finishes**

Cromo

Cromsatin/Cromo

# K 1162

design Valli Workshop

**Materiale Ottone**

*Material Brass*

**Finiture / Finishes**

Oro lucido

Anticato

Brunito

Zirtanio Oro lucido

110

K 1165 R8  
K 1165 R8 Y

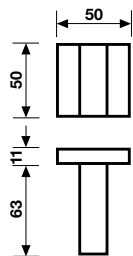

K 1162 A  
K 1162 Mis/size 80

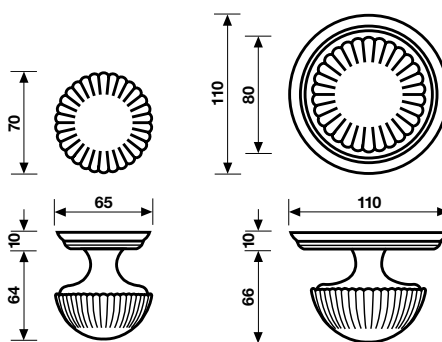

# K 1160

design Valli Workshop

## Materiale Ottone

Material Brass

## Finiture / Finishes

Oro lucido

Ottone naturale

Cromsatin

Zirtanio Oro lucido

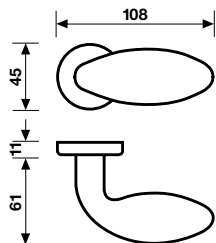

# K 1155

design Valli Workshop

## Materiale Ottone

Material Brass

## Finiture / Finishes

Oro lucido

Orsatin

Cromo

Cromsatin

Anticato

Brunito

Zirtanio Oro lucido

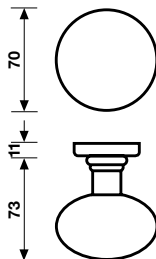

# K 1155

design Valli Workshop

## Materiale Ottone

Material Brass

## Finiture / Finishes

Oro lucido  
Orsatin  
Ottone naturale  
Cromo  
Cromsatin  
Anticato  
Brunito

112

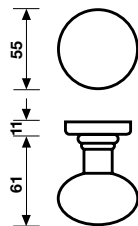

K 1155 R8  
K 1155 R8 Y

# K 1153

design Valli Workshop

## Materiale Ottone

Material Brass

## Finiture K1153 R SB

Finishes K1153 R SB

Oro lucido  
Cromsatin

## Finiture K1153 R Y

Finishes K1153 R Y

Oro lucido  
Cromsatin  
Zirtanio oro lucido

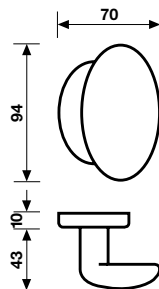

K 1153 R SB  
K 1153 R Y

# K 1153 PY

design Valli Workshop

**Materiale Ottone**

*Material Brass*

**Finiture / Finishes**

Oro lucido

Cromsatin

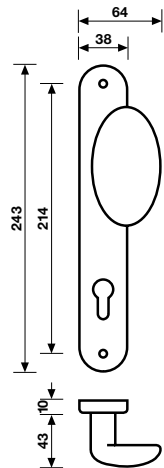

K 1153 PY D/S 85



# K 121 Serie Luigi XVI

design Valli Workshop

**Materiale Ottone**

*Material Brass*

**Finiture / Finishes**

Oro lucido

Ottone naturale antico

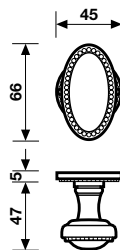

K 121 R8  
K 121 R8 Y



Valli&Valli

ASSA ABLOY

# K 120 Serie Luigi XV

design Valli Workshop

## Materiale Ottone

*Material Brass*

## Finiture / Finishes

Oro lucido

Ottone naturale antico

K 120 R8  
K 120 R8 Y

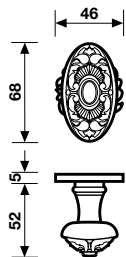

# K 465

design Valli Workshop

## Materiale Acciaio Inox AISI 304

*Material Stainless Steel AISI 304*

## Finiture / Finishes

Satinato

K465 R8  
K465 R8 Y

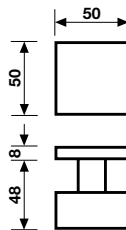

# K 1730

design Valli Workshop

**Materiale Ottone**

*Material Brass*

**Finiture / Finishes**

Oro

Cromo

Cromsatin

Nikmat

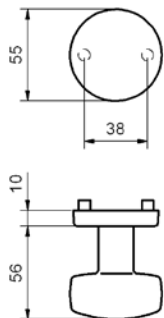

K 1730



Articolo solo disponibile con sottorosetta con perni per viti passanti  
*Article only available on anchor rose for bolt through fixing*

# K 142

design Valli Workshop

**Materiale Ottone**

*Material Brass*

**Finiture / Finishes**

Oro

Cromo

Cromsatin

Nikmat

Zirtoro

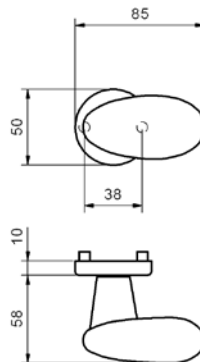

K 142



Articolo solo disponibile con sottorosetta con perni per viti passanti  
*Article only available on anchor rose for bolt through fixing*